

ILLINOIS CAPACITOR INC.

7/15/2011

3757 W. Touhy Ave. Lincolnwood, IL 60712 (847)-675-1760 FAX (847)-673-2850
 Illinois Capacitor (HK) Ltd., Tel: 85227930931, Fax: 85227930731, www.illcap.com.hk

PART NUMBER: 664MFP8700K##

Conduction Cooled Polypropylene Capacitors

Parts are RoHS compliant

Date code when parts became RoHS compliant: 21

ELECTRICAL SPECIFICATIONS

CAPACITANCE:

0.66 μ F

VAC:

700 Volts AC, 50/60Hz

RIPPLE CURRENT:

500 A

MAX POWER Kvar:

300

MAX TEMPERATURE RANGE:

+65°C

DISSIPATION FACTOR:

0.0005 Max at 1000 Hz and 25°C

ESR:

0.8 Ohms (typical)

Frequency:

147-200 kHz

Self inductance:

5nH

PHYSICAL SPECIFICATIONS

LENGTH (L): 56 mm (2H)/ 60 mm (4H)

HEIGHT (H): 66mm (2H)/ 60mm (4H)

THICKNESS (T): 30.2 mm

Lead Finish: Copper plates

Terminal Style: 4H

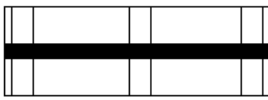

Terminal Style: 2H

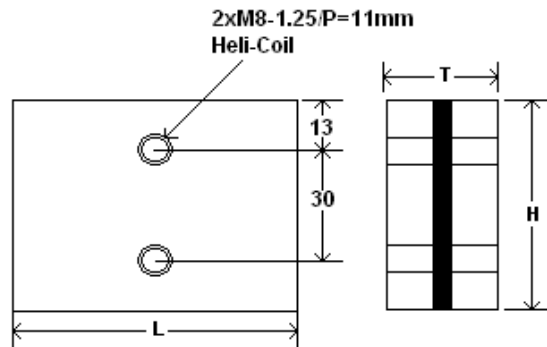
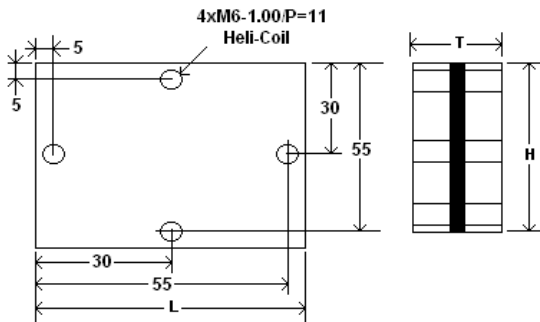
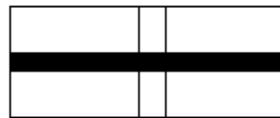

Replace ## in part number with desired lead style

0.66 MFD - 700 VRMS - 500 ARMS - 300 KVAR

